

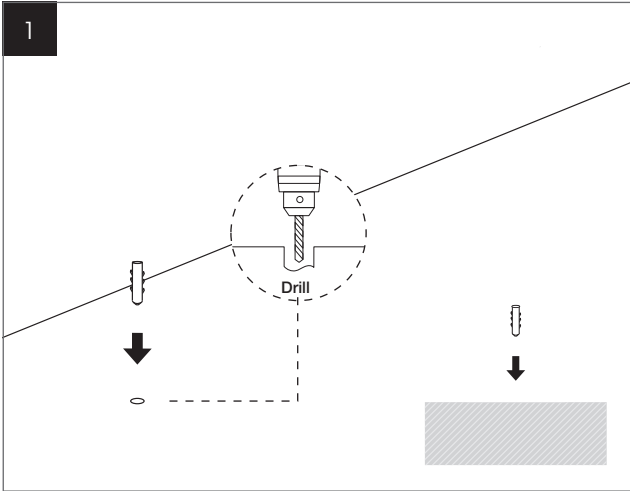

# WL25F / WL25F-PiX PROFILE

## FLAT RIGID LINEAR LUMINAIRE (WITH MOUNTING CLIP)

**PLEASE MAKE SURE THAT MAINS IS DISCONNECTED BEFORE PROCEEDING!**



Drill hole and place expansion plug.

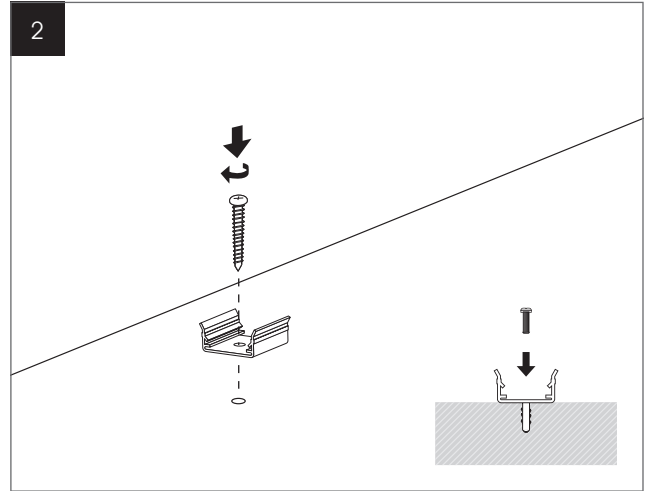

Screw the metal or plastic clip on the Surface.

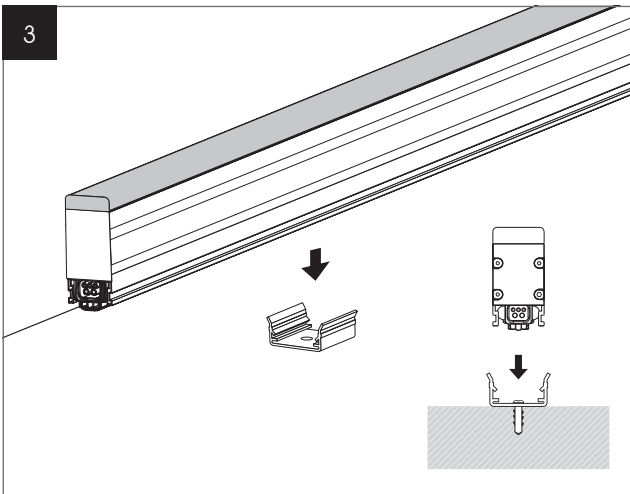

Attach Linear Profile to the clip.

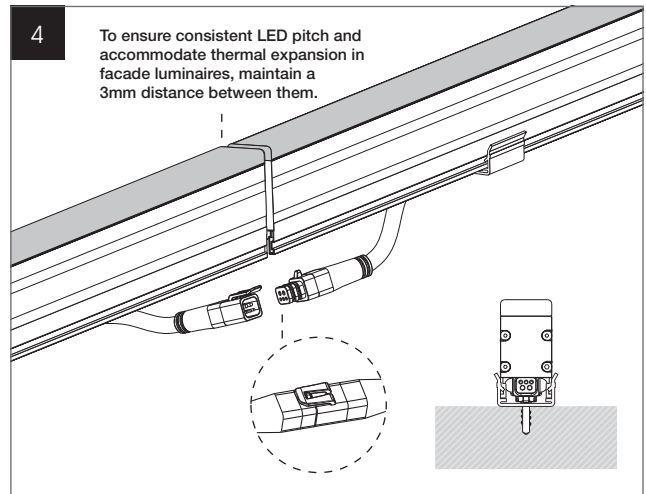

Connect the male and female waterproof connectors.

### SAFETY WARNING

- Products MUST be installed by a licensed electrician in accordance with local standards.
- Linear luminaire MUST ONLY be connected to 24V constant voltage LED driver. It is not compatible with any other type of driver. Failure to adhere to this will cause damage and void warranty.
- DO NOT COVER luminaire or driver under any circumstances.
- Ensure mains supply is not energised and/or disconnected prior to installation and connected/disconnection of linear luminaire from driver.
- Linear luminaire must not be Megger tested or connected during any in-circuit testing.
- No user serviceable parts. Do not attempt to disassemble or repair linear luminaire or driver.
- Do not use in flammable or explosive environments.
- Do not attempt to modify linear luminaire or supplied wiring in any way.
- Allow suitable air flow and ventilation around the linear luminaire.

### WARRANTY

Linear Works warrants that the products, when delivered in new condition and original packaging, will be free of defects in material and workmanship for a period of THREE (3) YEARS from the date of original purchase. Linear Works shall determine if the product is defective in its sole discretion with consideration given to the overall performance of the product. A product shall not be considered defective solely due to the failure of individual LED components to emit light if the number of inoperable components is less than 20% of the total number of LED components in the Product.

If the product is determined to be defective, Linear Works will elect, in its sole discretion, to refund the purchase price of the product, repair the product or replace the product. This extended warranty will not apply to loss or damage to the product caused by: negligence; abuse; misuse; mishandling; improper installation, storage or maintenance; damage due to fire or acts of God; vandalism; civil disturbances; power surges; improper power supply; electrical current fluctuations; corrosive environment installations; induced vibration; harmonic oscillation or resonance associated with movement of air currents around the product; alteration; accident; failure to follow installation, operating, maintenance or environmental instructions prescribed by Linear Works or applicable electrical codes; or improper service of the product performed by personnel other than Linear Works or its authorised service provider. Warranty excludes field labour and service charges related to the repair or replacement of the product.